

Local Air-conditioner

User Manual



BP109C | BP112C | BP112H
BP109AC | BP109AH | BP113H
EN | FR | IT | NL | DE | PT | HR

06M-8891923200-1121-05

beko

CONTENTS

ENGLISH	4-56
FRANÇAIS	58-113
ITALIANO	115-169
NEDERLANDS	171-225
DEUTSCH	227-281
PORTUGUÊS	283-338
HRVATSKI	340-392

Please read this user manual first

Dear Customer,

Thank you for preferring a Beko product. We hope that you get the best results from your product which has been manufactured with high quality and state-of-the-art technology. Therefore, please read this entire user manual and all other accompanying documents carefully before using the product and keep it as a reference for future use. If you handover the product to someone else, give the user manual as well. Follow all warnings and information in the user manual.

Meanings of the symbols

Following symbols are used in the various section of this manual:

	Important information or useful hints about usage.
--	--

	Warning for hazardous situations with regard to life and property.
--	--

	Warning to actions that must never perform.
--	---

	Warning for electric shock.
---	-----------------------------

	Warning for hot surfaces.
--	---------------------------

	Do not cover it.
--	------------------

	This symbol shows that the operation manual should be read carefully.
---	---

	This symbol shows that a service personnel should be handling this equipment with reference to the installation manual.
---	---

	This symbol shows that this appliance used a flammable refrigerant. If the refrigerant is leaked and exposed to an external ignition source, there is a risk of fire.
---	---



This product has been produced in environmentally friendly, modern facilities

Contents

1	Safety awareness	6
2	Name of parts	30
3	Accessories	31
4	Appearance and function of control panel	32
4.1	Cooling only model (non-reversible).....	32
4.2	Cooling & Heat pump model (reversible)	33
5	Appearance and function of remote control	34
6	Operation introduction	36
6.1	Before using	36
6.2	Cooling operation	37
6.3	Dehumidifying operation	37
6.4	Fan operation	37
6.5	Heating operation (this function is not available for a cold- single unit)	37
6.6	Timer operation	37
6.7	Auto swing	38
6.8	Sleep mode.....	38
6.9	Water drainage.....	38
6.10	Wireless function 	39
6.11	Zone follow function	39
7	Installation explanations	40
7.1	Installation explanations:	40
7.2	Introduction to exhaust hose installation.....	41
7.3	Universal caulking kit accessory for mobile air conditioner (optional).....	43
7.4	Use the Hepa 13 filter (only for BP113H model).....	46
7.5	Water full alarm	47

Contents

8 Maintenance explanations	48
8.1 Clean the air filter	48
8.2 Clean the air-conditioner surface	49
9 Maintenance	50
10 Troubleshooting	51
11 European disposal guideline	52
12 Installation instructions	53
12.1 F-Gas instruction	53
13 Specifications	54

1 Safety awareness

Very important

Please do not install or use your Local air conditioner before you have carefully read this manual. Please keep this instruction manual for an eventual product warranty and for future reference.

Warning

Do not use means to accelerate the defrosting process or to clean, other than those recommended by the manufacturer.

The appliance shall be stored in a room without continuously operating ignition sources (for example: open flames, an operating gas appliance or an operating electric heater).

Do not pierce or burn.

Be aware the refrigerants may not contain an odour.

Appliance shall be installed, operated and stored in a room with a floor area larger than X m².

Model	X (m ²)
9000Btu/h, 10000Btu/h, 12000Btu/h, 13000Btu/h	12

Warning (for R290)

Specific information regarding appliances with R290 refrigerant gas.

- Thoroughly read all of the warnings.
- When defrosting and cleaning the appliance, do not use any tools other than those recommended by the manufacturing company.
- The appliance must be placed in an area without any continuously sources of ignition (for example: open flames, gas or electrical appliances in operation).
- Do not puncture and do not burn.
- This appliance contains Y g (see rating label back of unit) of R290 refrigerant gas.
- R290 is a refrigerant gas that complies with the European directives on the environment. Do not puncture any part of the refrigerant circuit.
- If the appliance is installed, operated or stored in an unventilated area, the room must be designed to prevent to the accumulation of refrigerant leaks resulting in a risk of fire or explosion due to ignition of the refrigerant caused by electric heaters, stoves, or other sources of ignition.
- The appliance must be stored in such a way as to prevent mechanical failure.
- Individuals who operate or work on the refrigerant circuit must have the appropriate certification issued by an accredited organization that ensures competence in handling refrigerants according to a specific evaluation recognized by associations in the industry.

1 Safety awareness

- Repairs must be performed based on the recommendation from the manufacturing company. Maintenance and repairs that require the assistance of other qualified personnel must be performed under the supervision of an individual specified in the use of flammable refrigerants.

General safety instruction

1. The appliance is for indoor use only.
2. Do not use the unit on a socket under repairs or not installed properly.
3. Do not use the unit, follow these precautions:
 - A: Near to source of fire.
 - B: An area where oil is likely to splash.
 - C: An area exposed to direct sunlight.
 - D: An area where water is likely to splash.
 - E: Near a bath, a laundry, a shower or a swimming pool.
4. Never insert your fingers, rods into the air outlet. Take special care to warn children of these dangers.
5. Keep the unit upward while transport and storage, for the compressor locates properly.
6. Before cleaning the air-conditioner, always turn off or disconnect the power supply.
7. When moving the air-conditioner, always turn off and disconnect the power supply, and move it slowly.

1 Safety awareness

8. To avoid the possibility of fire disaster, the air-conditioner shall not be covered.
9. All the air-conditioner sockets must comply with the local electric safety requirements. If necessary, please check it for the requirements.
10. Children should be supervised to ensure that they do not play with the appliance.
11. If the supply cord is damaged, it must be replaced by the manufacturer, its service agent or similarly qualified persons in order to avoid a hazard.
12. This appliance can be used by children aged from 8 years and above and persons with reduced physical, sensory or mental capabilities or lack of experience and knowledge if they have been given supervision or instruction concerning use of the appliance in a safe way and understand the hazards involved. Children shall not play with the appliance. Cleaning and user maintenance shall not be made by children without supervision.
13. The appliance shall be installed in accordance with national wiring regulations.
14. Details of type and rating of fuses: T, 250V AC, 2A or higher.
15. Contact authorized service technician for repair or maintenance of this unit.
16. Do not pull, deform, or modify the power supply cord, or immerse it in water. Pulling or misuse of the power supply cord can result in damage to the unit and cause electrical shock.
17. Compliance with national gas regulations shall be observed.

1 Safety awareness

18. Keep ventilation openings clear of obstruction.
19. Any person who is involved with working on or breaking into a refrigerant circuit should hold a current valid certificate from an industry-accredited assessment authority, which authorizes their competence to handle refrigerants safely in accordance with an industry recognized assessment specification.
20. Servicing shall only be performed as recommended by the equipment manufacturer. Maintenance and repair requiring the assistance of other skilled personnel shall be carried out under the supervision of the person competent in the use of flammable refrigerants.
21. Do not operate or stop the unit by inserting or pulling out the power plug, it may cause electric shock or fire due to heat generation.
22. Unplug the unit if strange sounds, smell, or smoke comes from it.
23. This appliance is not intended for use by persons (including children) with reduced physical, sensory or mental capabilities, or lack of experience and knowledge, unless they have been given supervision or instruction concerning use of the appliance by a person responsible for their safety.
24. If the supply cord is damaged, it must be replaced by the manufacturer or its agent or similarly qualified person in order to avoid hazard.
25. The appliance shall state the insulation of a residual current device (RCD) having rated residual operating current not exceeding 30mA.

1 Safety awareness

26. This appliance is intended to be used in household and similar applications such as

- Staff kitchen areas in shops, offices and other working environments;
- farm houses;
- by clients in hotels, motels and other residential type environments;
- bed and breakfast type environments;

The appliance shall state the insulation of a residual current device (RCD) having rated residual operating current not exceeding 30mA.

27. Impedance declaration

These appliances can be connected only to a supply with system impedance no more than 0.367Ω . In case necessary, please consult your supply authority for system impedance information.

1 Safety awareness



Note:

- If any parts damage, please contact the dealer or a designated repair shop;
- In case of any damage, please turn off the air switch, disconnect the power supply, and contact the dealer or a designated repair shop;
- In any case, the power cord shall be firmly grounded.
- To avoid the possibility of danger, if power cord is damaged, please turn off the air switch and disconnect the power supply. It must be replaced from the dealer or a designated repair shop.



Warnings (for using R290 refrigerant only)

1. General instructions

1.1 Checks to the area

Prior to beginning work on systems containing flammable refrigerants, safety checks are necessary to ensure that the risk of ignition is minimized. For repair to the refrigerating system, the following precautions shall be complied with prior to conducting work on the system.

1.2 Work procedure

Work shall be undertaken under a controlled procedure so as to minimize the risk of a flammable gas or vapour being present while the work is being performed.

1.3 General work area

All maintenance staff and others working in the local area shall be instructed on the nature of work being carried out. Work in confined spaces shall be avoided. The area around the workspace shall be sectioned off. Ensure that the conditions within the area have been made safe by control of flammable material.

1.4 Checking for presence of refrigerant

The area shall be checked with an appropriate refrigerant detector prior to and during work, to ensure the technician is aware of potentially flammable atmospheres. Ensure that the leak detection equipment being used is suitable for use with flammable refrigerants, i.e. nonsparking, adequately sealed or intrinsically safe.

1 Safety awareness

1.5 Presence of fire extinguisher

If any hot work is to be conducted on the refrigeration equipment or any associated parts, appropriate fire extinguishing equipment shall be available to hand. Have a dry powder or CO₂ fire extinguisher adjacent to the charging area.

1.6 No ignition sources

No person carrying out work in relation to a refrigeration system which involves exposing any pipe work that contains or has contained flammable refrigerant shall use any sources of ignition in such a manner that it may lead to the risk of fire or explosion. All possible ignition sources, including cigarette smoking, should be kept sufficiently far away from the site of installation, repairing, removing and disposal, during which flammable refrigerant can possibly be released to the surrounding space. Prior to work taking place, the area around the equipment is to be surveyed to make sure that there are no flammable hazards or ignition risks. "No Smoking" signs shall be displayed.

1.7 Ventilated area

Ensure that the area is in the open or that it is adequately ventilated before breaking into the system or conducting any hot work. A degree of ventilation shall continue during the period that the work is carried out. The ventilation should safely disperse any released refrigerant and preferably expel it externally into the atmosphere.

1 Safety awareness

1.8 Checks to the refrigeration equipment

Where electrical components are being changed, they shall be fit for the purpose and to the correct specification. At all times the manufacturer's maintenance and service guidelines shall be followed. If in doubt consult the manufacturer's technical department for assistance. The following checks shall be applied to installations using flammable refrigerants: the charge size is in accordance with the room size within which the refrigerant containing parts are installed; the ventilation machinery and outlets are operating adequately and are not obstructed; if an indirect refrigerating circuit is being used, the secondary circuit shall be checked for the presence of refrigerant; marking to the equipment continues to be visible and legible. Markings and signs that are illegible shall be corrected; refrigeration pipe or components are installed in a position where they are unlikely to be exposed to any substance which may corrode refrigerant containing components, unless the components are constructed of materials which are inherently resistant to being corroded or are suitably protected against being so corroded.

1.9 Checks to electrical devices

Repair and maintenance to electrical components shall include initial safety checks and component inspection procedures. If a fault exists that could compromise safety, then no electrical supply shall be connected to the circuit until it is satisfactorily dealt with. If the fault cannot be corrected immediately but it is necessary to continue operation, an adequate temporary solution shall be used. This shall be reported to the owner of the equipment so all parties are advised.

1 Safety awareness

Initial safety checks shall include: that capacitors are discharged; this shall be done in a safe manner to avoid possibility of sparking; that there no live electrical components and wiring are exposed while charging, recovering or purging the system; that there is continuity of earth bonding.

2. Repairs to sealed components

2.1 During repairs to sealed components, all electrical supplies shall be disconnected from the equipment being worked upon prior to any removal of sealed covers, etc. If it is absolutely necessary to have an electrical supply to equipment during servicing, then a permanently operating form of leak detection shall be located at the most critical point to warn of a potentially hazardous situation.

2.2 Particular attention shall be paid to the following to ensure that by working on electrical components, the casing is not altered in such a way that the level of protection is affected. This shall include damage to cables, excessive number of connections, terminals not made to original specification, damage to seals, incorrect fitting of glands, etc. Ensure that apparatus is mounted securely. Ensure that seals or sealing materials have not degraded such that they no longer serve the purpose of preventing the ingress of flammable atmospheres. Replacement parts shall be in accordance with the manufacturer's specifications.

1 Safety awareness



Note: The use of silicon sealant may inhibit the effectiveness of some types of leak detection equipment. Intrinsically safe components do not have to be isolated prior to working on them.

3. Repair to intrinsically safe components

Do not apply any permanent inductive or capacitance loads to the circuit without ensuring that this will not exceed the permissible voltage and current permitted for the equipment in use.

Intrinsically safe components are the only types that can be worked on while live in the presence of a flammable atmosphere. The test apparatus shall be at the correct rating. Replace components only with parts specified by the manufacturer. Other parts may result in the ignition of refrigerant in the atmosphere from a leak.

4. Cabling

Check that cabling will not be subject to wear, corrosion, excessive pressure, vibration, sharp edges or any other adverse environmental effects. The check shall also take into account the effects of aging or continual vibration from sources such as compressors or fans.

5. Detection of flammable refrigerants

Under no circumstances shall potential sources of ignition be used in the searching for or detection of refrigerant leaks. A halide torch (or any other detector using a naked flame) shall not be used.

6. Leak detection methods

The following leak detection methods are deemed acceptable for systems containing flammable refrigerants. Electronic leak detectors shall be used to detect flammable refrigerants, but the sensitivity may not be adequate, or may need recalibration. (Detection equipment shall be calibrated in a refrigerant-free area.) Ensure that the detector is not a potential source of ignition and is suitable for the refrigerant used. Leak detection equipment shall be set at a percentage of the LFL of the refrigerant and shall be calibrated to the refrigerant employed and the appropriate percentage of gas (25 % maximum) is confirmed. Leak detection fluids are suitable for use with most refrigerants but the use of detergents containing chlorine shall be avoided as the chlorine may react with the refrigerant and corrode the copper pipe-work. If a leak is suspected, all naked flames shall be removed/extinguished. If a leakage of refrigerant is found which requires brazing, all of the refrigerant shall be recovered from the system, or isolated (by means of shut off valves) in a part of the system remote from the leak. Oxygen free nitrogen (OFN) shall then be purged through the system both before and during the brazing process.

7. Removal and evacuation

When breaking into the refrigerant circuit to make repairs – or for any other purpose – conventional procedures shall be used. However, it is important that best practice is followed since flammability is a consideration. The following procedure shall be adhered to: remove refrigerant; purge the circuit with inert gas; evacuate; purge again with inert gas; open the circuit by cutting or brazing. The refrigerant charge shall be recovered into the correct recovery cylinders. The system shall be “flushed” with OFN to render the unit safe. This process may need to be repeated several times. Compressed air or oxygen shall not be used for this task. Flushing shall be achieved by breaking the vacuum in the system with OFN and continuing to fill until the working pressure is achieved, then venting to atmosphere, and finally pulling down to a vacuum. This process shall be repeated until no refrigerant is within the system. When the final OFN charge is used, the system shall be vented down to atmospheric pressure to enable work to take place. This operation is absolutely vital if brazing operations on the pipework are to take place.

Ensure that the outlet for the vacuum pump is not close to any ignition sources and there is ventilation available.

8. Charging procedures

In addition to conventional charging procedures, the following requirements shall be followed.

- Ensure that contamination of different refrigerants does not occur when using charging equipment. Hoses or lines shall be as short as possible to minimise the amount of refrigerant contained in them.

1 Safety awareness

- Cylinders shall be kept upright.
- Ensure that the refrigeration system is earthed prior to charging the system with refrigerant.
- Label the system when charging is complete (if not already).
- Extreme care shall be taken not to overfill the refrigeration system.

Prior to recharging the system it shall be pressure tested with OFN. The system shall be leak tested on completion of charging but prior to commissioning. A follow up leak test shall be carried out prior to leaving the site.

9. Decommissioning

Before carrying out this procedure, it is essential that the technician is completely familiar with the equipment and all its detail. It is recommended good practice that all refrigerants are recovered safely. Prior to the task being carried out, an oil and refrigerant sample shall be taken in case analysis is required prior to re-use of reclaimed refrigerant. It is essential that electrical power is available before the task is commenced.

- a) Become familiar with the equipment and its operation.
- b) Isolate system electrically.
- c) Before attempting the procedure ensure that: mechanical handling equipment is available, if required, for handling refrigerant cylinders; all personal protective equipment is available and being used correctly; the recovery process is supervised at all times by a competent person; recovery equipment and cylinders conform to the appropriate standards.

1 Safety awareness

- d) Pump down refrigerant system, if possible.
- e) If a vacuum is not possible, make a manifold so that refrigerant can be removed from various parts of the system.
- f) Make sure that cylinder is situated on the scales before recovery takes place.
- g) Start the recovery machine and operate in accordance with manufacturer's instructions.
- h) Do not overfill cylinders. (No more than 80 % volume liquid charge).
- i) Do not exceed the maximum working pressure of the cylinder, even temporarily.
- j) When the cylinders have been filled correctly and the process completed, make sure that the cylinders and the equipment are removed from site promptly and all isolation valves on the equipment are closed off.
- k) Recovered refrigerant shall not be charged into another refrigeration system unless it has been cleaned and checked.

10. Labelling

Equipment shall be labelled stating that it has been de-commissioned and emptied of refrigerant. The label shall be dated and signed.

Ensure that there are labels on the equipment stating the equipment contains flammable refrigerant.

11. Recovery

When removing refrigerant from a system, either for servicing or decommissioning, it is recommended good practice that all refrigerants are removed safely. When transferring refrigerant into cylinders, ensure that only appropriate refrigerant recovery cylinders are employed. Ensure that the correct number of cylinders for holding the total system charge are available. All cylinders to be used are designated for the recovered refrigerant and labelled for that refrigerant (i.e. special cylinders for the recovery of refrigerant). Cylinders shall be complete with pressure relief valve and associated shut-off valves in good working order. Empty recovery cylinders are evacuated and, if possible, cooled before recovery occurs.

The recovery equipment shall be in good working order with a set of instructions concerning the equipment that is at hand and shall be suitable for the recovery of flammable refrigerants. In addition, a set of calibrated weighing scales shall be available and in good working order. Hoses shall be complete with leak-free disconnect couplings and in good condition. Before using the recovery machine, check that it is in satisfactory working order, has been properly maintained and that any associated electrical components are sealed to prevent ignition in the event of a refrigerant release. Consult manufacturer if in doubt.

The recovered refrigerant shall be returned to the refrigerant supplier in the correct recovery cylinder, and the relevant waste transfer note arranged. Do not mix refrigerants in recovery units and especially not in cylinders.

1 Safety awareness

If compressors or compressor oils are to be removed, ensure that they have been evacuated to an acceptable level to make certain that flammable refrigerant does not remain within the lubricant. The evacuation process shall be carried out prior to returning the compressor to the suppliers. Only electric heating to the compressor body shall be employed to accelerate this process. When oil is drained from a system, it shall be carried out safely.

Note about fluorinated gasses:



- Fluorinated greenhouse gases are contained in hermetically sealed equipment. For specific information on the type, the amount and the CO₂ equivalent in tonnes of the fluorinated greenhouse gas (on some models), please refer to the relevant label on the unit itself.
- Installation, service, maintenance and repair of this unit must be performed by a certified technician.
- Product uninstallation and recycling must be performed by a certified technician.

Competence of service personnel

General

Special training additional to usual refrigerating equipment repair procedures is required when equipment with flammable refrigerants is affected.

1 Safety awareness

In many countries, this training is carried out by national training organizations that are accredited to teach the relevant national competency standards that may be set in legislation.

The achieved competence should be documented by a certificate.

Training

The training should include the substance of the following:

Information about the explosion potential of flammable refrigerants to show that flammables may be dangerous when handled without care.

Information about potential ignition sources, especially those that are not obvious, such as lighters, light switches, vacuum cleaners, electric heaters.

Information about the different safety concepts:

Unventilated - (see Clause GG.2) Safety of the appliance does not depend on ventilation of the housing. Switching off the appliance or opening of the housing has no significant effect on the safety. Nevertheless, it is possible that leaking refrigerant may accumulate inside the enclosure and flammable atmosphere will be released when the enclosure is opened.

Ventilated enclosure - (see Clause GG.4) Safety of the appliance depends on ventilation of the housing. Switching off the appliance or opening of the enclosure has a significant effect on the safety. Care should be taken to ensure a sufficient ventilation before.

1 Safety awareness

Ventilated room - (see Clause GG.5) Safety of the appliance depends on the ventilation of the room. Switching off the appliance or opening of the housing has no significant effect on the safety. The ventilation of the room shall not be switched off during repair procedures.

Information about the concept of sealed components and sealed enclosures according to IEC 60079-15:2010.

Information about the correct working procedures:

a) Commissioning

- Ensure that the floor area is sufficient for the refrigerant charge or that the ventilation duct is assembled in a correct manner.
- Connect the pipes and carry out a leak test before charging with refrigerant.
- Check safety equipment before putting into service.

b) Maintenance

- Local equipment shall be repaired outside or in a workshop specially equipped for servicing units with flammable refrigerants.
- Ensure sufficient ventilation at the repair place.
- Be aware that malfunction of the equipment may be caused by refrigerant loss and a refrigerant leak is possible.
- Discharge capacitors in a way that won't cause any spark. The standard procedure to short circuit the capacitor terminals usually creates sparks.
- Reassemble sealed enclosures accurately. If seals are worn, replace them.
- Check safety equipment before putting into service.

1 Safety awareness

c) Repair

- Local equipment shall be repaired outside or in a workshop specially equipped for servicing units with flammable refrigerants.
- Ensure sufficient ventilation at the repair place.
- Be aware that malfunction of the equipment may be caused by refrigerant loss and a refrigerant leak is possible.
- Discharge capacitors in a way that won't cause any spark.
- When brazing is required, the following procedures shall be carried out in the right order:
 - Remove the refrigerant. If the recovery is not required by national regulations, drain the refrigerant to the outside. Take care that the drained refrigerant will not cause any danger. In doubt, one person should guard the outlet. Take special care that drained refrigerant will not float back into the building.
 - Evacuate the refrigerant circuit.
 - Purge the refrigerant circuit with nitrogen for 5 min.
 - Evacuate again.
 - Remove parts to be replaced by cutting, not by flame.
 - Purge the braze point with nitrogen during the brazing procedure.
 - Carry out a leak test before charging with refrigerant.
- Reassemble sealed enclosures accurately. If seals are worn, replace them.
- Check safety equipment before putting into service.

1 Safety awareness

d) Decommissioning

- If the safety is affected when the equipment is putted out of service, the refrigerant charge shall be removed before decommissioning.
- Ensure sufficient ventilation at the equipment location.
- Be aware that malfunction of the equipment may be caused by refrigerant loss and a refrigerant leak is possible.
- Discharge capacitors in a way that won't cause any spark.
- Remove the refrigerant. If the recovery is not required by national regulations, drain the refrigerant to the outside. Take care that the drained refrigerant will not cause any danger. In doubt, one person should guard the outlet. Take special care that drained refrigerant will not float back into the building.
- Evacuate the refrigerant circuit.
- Purge the refrigerant circuit with nitrogen for 5 min.
- Evacuate again.
- Fill with nitrogen up to atmospheric pressure.
- Put a label on the equipment that the refrigerant is removed.

e) Disposal

- Ensure sufficient ventilation at the working place.
- Remove the refrigerant. If the recovery is not required by national regulations, drain the refrigerant to the outside. Take care that the drained refrigerant will not cause any danger. In doubt, one person should guard the outlet. Take special care that drained refrigerant will not float back into the building.

1 Safety awareness

- Evacuate the refrigerant circuit.
- Purge the refrigerant circuit with nitrogen for 5 min.
- Evacuate again.
- Cut out the compressor and drain the oil.

Transportation, marking and storage for units that employ flammable refrigerants

Transport of equipment containing flammable refrigerants

Attention is drawn to the fact that additional transportation regulations may exist with respect to equipment containing flammable gas. The maximum number of pieces of equipment or the configuration of the equipment, permitted to be transported together will be determined by the applicable transport regulations.

Marking of equipment using signs

Signs for similar appliances used in a work area generally are addressed by local regulations and give the minimum requirements for the provision of safety and/or health signs for a work location.

All required signs are to be maintained and employers should ensure that employees receive suitable and sufficient instruction and training on the meaning of appropriate safety signs and the actions that need to be taken in connection with these signs.

The effectiveness of signs should not be diminished by too many signs being placed together.

Any pictograms used should be as simple as possible and contain only essential details.

Disposal of equipment using flammable refrigerants

See national regulations.

Storage of equipment/appliances

The storage of equipment should be in accordance with the manufacturer's instructions.

Storage of packed (unsold) equipment

Storage package protection should be constructed such that mechanical damage to the equipment inside the package will not cause a leak of the refrigerant charge.

The maximum number of pieces of equipment permitted to be stored together will be determined by local regulations.

2 Name of parts

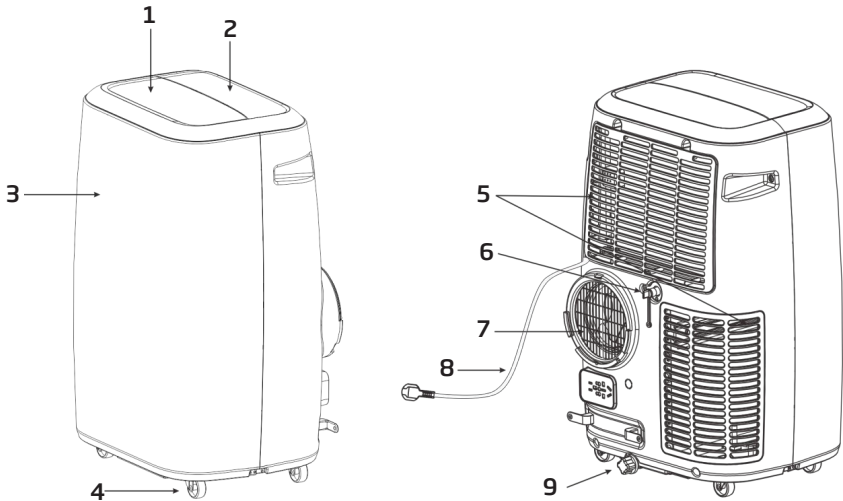



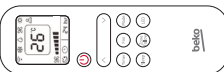









Fig.1

1	Louver	5	Air inlet
2	Control panel	6	Drainage outlet
3	Front cover	7	Air outlet
4	Castor	8	Power cord
		9	Drainage outlet

3 Accessories

Part	Description	Quantity
	Exhaust hose	1
	Window connector	1
	Housing adaptor	1
	Remote controller	1
	Window kit	1
	Dowel	1
	Fabric window kit	1 (optional)
	Roll ribbon	1 (optional)
	Air outlet	1
	Water pipe	1
	Batteries	2

After unpacking, please check whether the above-mentioned accessories are included, and check their purposes in the installation introduction in this manual.

4 Appearance and function of control panel

4.1 Cooling only model (non-reversible)

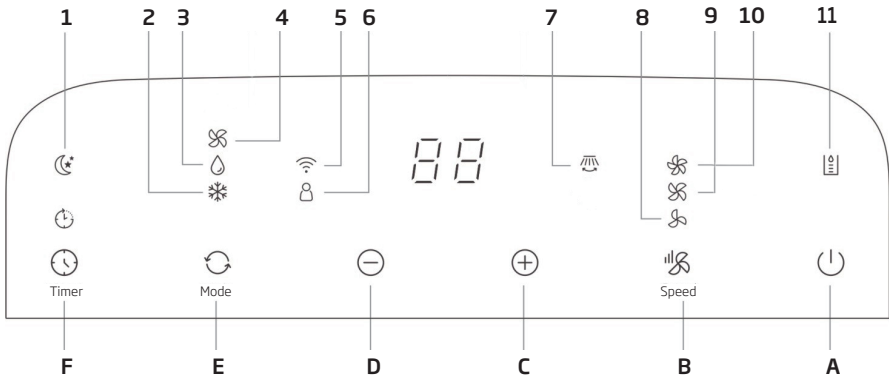

A	Power on/off	4	Fan
B	Fan speed	5	Wireless function
C	Temperature up	6	Zone follow
D	Temperature down	7	Auto swing
E	Operation mode	8	Low fan speed
F	Timer on/off	9	Medium fan speed
1	Sleep mode	10	High fan speed
2	Cooling	11	Water full
3	Dehumidifying		

4 Appearance and function of control panel

4.2 Cooling & Heat pump model (reversible)

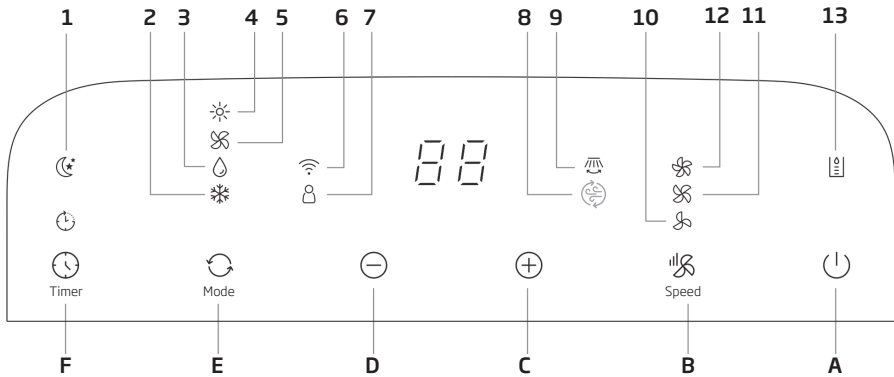

A	Power on/off	4	Heating
B	Fan speed	5	Fan
C	Temperature up	6	Wireless function
D	Temperature down	7	Zone follow
E	Operation mode	8	Hepa 13 filter indicator (present on BP113H only)
F	Timer on/off	9	Auto swing
		10	Low fan speed
1	Sleep mode	11	Medium fan speed
2	Cooling	12	High fan speed
3	Dehumidifying	13	Water full

1080 hours is recommended for the HEPA filter using.

- When the accumulated time of the purification sensor is switched on for 1080 hours, the "HEPA 13 filter indicator" flashes to remind the replacement of a new HEPA filter
- Reset: After HEPA is replaced, long press the TIMER button 5 seconds to confirm the reset. At this time, the "HEPA 13 filter indicator" stops flashing and the time is reset again.

Note:



- Please keep HEPA 13 filter stored in well conditioner when you don't use it on product. Otherwise, HEPA life time would be affected and shorten usage time.
- When HEPA 13 filter is taken out from product / package for 1 year or more, we suggest to replace with new HEPA 13 filter for better air cleaning performance.
- Suggested working hours depends on room size, air quality environment etc.

5 Appearance and function of remote control

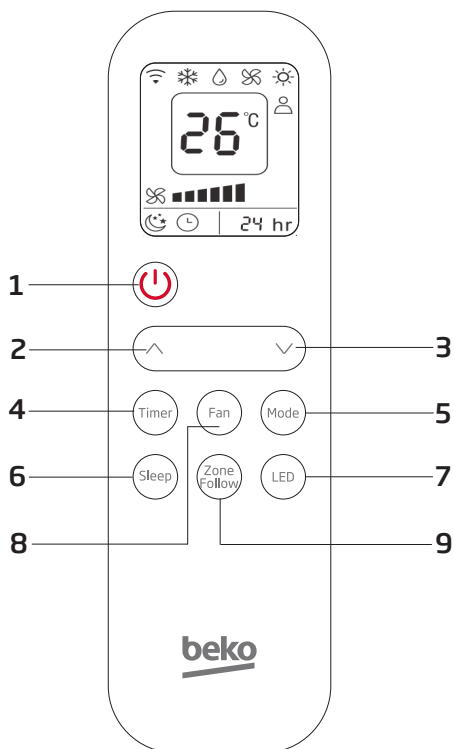

1. Power on/off
2. Temperature up
3. Temperature down
4. Timer on/off
5. Operation mode

6. Sleep mode
7. LED display
8. Fan speed
9. Zone Follow

5 Appearance and function of remote control

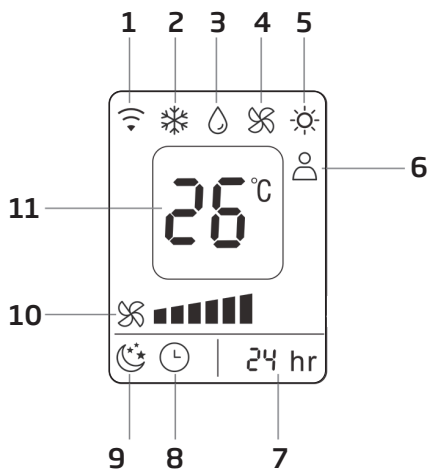

- | | |
|--|-------------------------|
| 1. Receiver signal  | 7. Timing |
| 2. Cooling | 8. Timer on/off |
| 3. Dehumidifying | 9. Sleep mode |
| 4. Fan | 10. Fan speed |
| 5. Heating | 11. Temperature display |
| 6. Zone follow | |



Note:

- Do not drop the remote controller.
- Do not place the remote controller in a location exposed to direct sunlight.

6 Operation introduction

Before starting operations in this section:

1. Find a place where there is power supply nearby.
2. As shown in Fig. 5 and Fig. 5a, install the exhaust hose, and adjust the window position well.

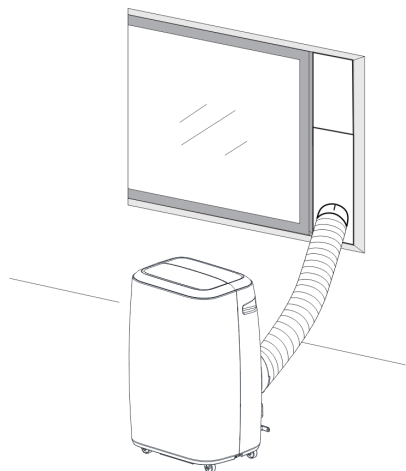

Fig. 5

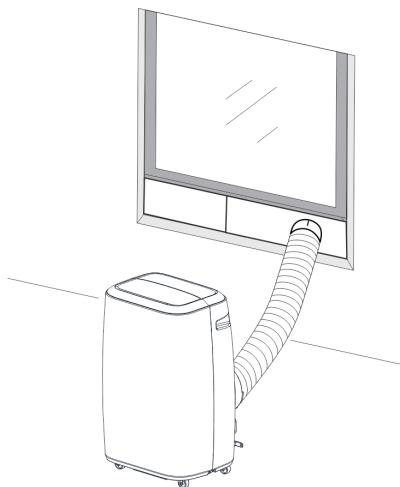

Fig. 5a

3. Connect drain hose well (only for using heating model);
4. Insert the power cord into a grounded AC220~240V/50Hz socket;
5. Press the Power button to turn on the air-conditioner.

6.1 Before using

Notice:

- **Operation temperature range:**

	Maximum cooling	Minimum cooling
DB/WB(°C)	35/24	18/12

	Maximum heating	Minimum heating
DB/WB(°C)	27/---	7/---

6 Operation introduction

Check up whether the exhaust hose has been mounted properly.

Cautions for cooling and dehumidifying operations:

- When using functions on cooling and dehumidifying, keep an interval of at least 3 minutes between each On/Off.
- Power supply meets the requirements.
- The socket is for AC use.
- Do not share one socket with other appliances.
- Power supply is AC220--240V, 50Hz

6.2 Cooling operation

- Press the "Mode" button till the "Cool" icon appears.
- Press the "Down" or "Up" button to select a desired room temperature. (16°C-31°C)
- Press the "Wind" button to select wind speed.

6.3 Dehumidifying operation

- Press the "Mode" button till the "Dehumidify" icon appears.
- Automatically set the selected temperature to current room temperature minus 2°C. (16°C-31°C)
- Automatically set the fan motor to Low wind speed.

6.4 Fan operation

- Press the "Mode" button till the "Fan" icon appears.
- Press the "Wind" button to select wind speed.

6.5 Heating operation (this function is not available for a cold- single unit)

- Press the "Mode" button till the "Heat" icon appears.
- Press the "Down" or "Up" button to select a desired room temperature. (16°C-31°C)
- Press the "Wind" button to select wind speed.

6.6 Timer operation

Timer On setting:

- When the air-conditioner is Off, press the "Timer" button and select a desired On time through the temperature and time setting buttons.
- "Preset On Time" is displayed on the operation panel, after setting time 5 seconds, 'set temperature' will be shown on both display.
- On time can be regulated at any time in 0-24 hours.

6 Operation introduction

Timer Off setting:

- When the air-conditioner On, press "Timer" button and select a desired Off time through the temperature and time setting buttons.
- "Preset Off Time" is displayed on the operation panel.
- Off time can be regulated at any time in 0-24 hours.

6.7 Auto swing

- This function could be only realized through Homewhiz app.

6.8 Sleep mode

- While in cooling mode, press the Sleep key to set the temperature. It increases 1°C after an hour and at most increases 2°C after 2 hours.
- While in heating mode, press the Sleep key to set the temperature. It decreases 1°C after an hour and at most decreases 2°C after 2 hours.
- Press the Sleep key again can cancel the setting.

6.9 Water drainage

Water full alarm

- The inner water tray inside the air-conditioner has one water level safety switches, it controls water level. When water level reaches an anticipated height, the water full indicator lamp lights up. (If water pump is damaged, when the water is full, please remove the rubber blockage at the bottom of unit, and all water will drain outside.)

Continuous drainage

- When you plan to leave this unit unused for a long time, please remove the rubber blockage from the drainage hole at the bottom of unit, and connect a drain hose to the lower fixing clip. All the water in the water tank will drain outside.
- You can drain the water as the above when the unit working at the heat mode and dehumidifying mode.
- If water pump is damaged, continuous drainage can be used, and under this condition, the water pump is not activated. The unit can also work well.
If water pump is damaged, intermittent drainage can also be used. Under this condition, when the water full indicator lamp lights up, please connect a drain hose to the lower fixing clip, then all the water in the water tray will be drained outside. The unit can also work well.

6 Operation introduction

6.10 Wireless function

- Long press the Speed button for 5s, enter the wireless factory set up mode;
- The unit is connected with wireless If the wireless indicator is on, otherwise is not connected. When the wireless indicator flashing slowly, the unit is at the wireless set up mode, if flashing quickly, the unit is connected with wireless;
- You can realize most of the air conditioner functions by the mobile phone APP (HomeWhiz) with the wireless connected.

6.11 Zone follow function

- You can switch on or off the Zone follow function through the remote controller;
- When this function is on, the unit will control the temperature of the room by the temperature sensor inside the remote controller (the room temperature sensor inside the machine will not work again)
- This function will be off if the unit have not received the signal from the remote controller in 30 minutes. It will switch to the normal room temperature sensor inside the unit to control the temperature.

7 Installation explanations

7.1 Installation explanations:

- A removal air-conditioner shall be installed in the flat and empty place all around. Don't block the air outlet, and the required distance around should be at least 30cm. (See Fig. 8)
- Should not be installed in wet location, such as the laundry room.
- Socket wiring should be in accordance with the local electric safety requirements.

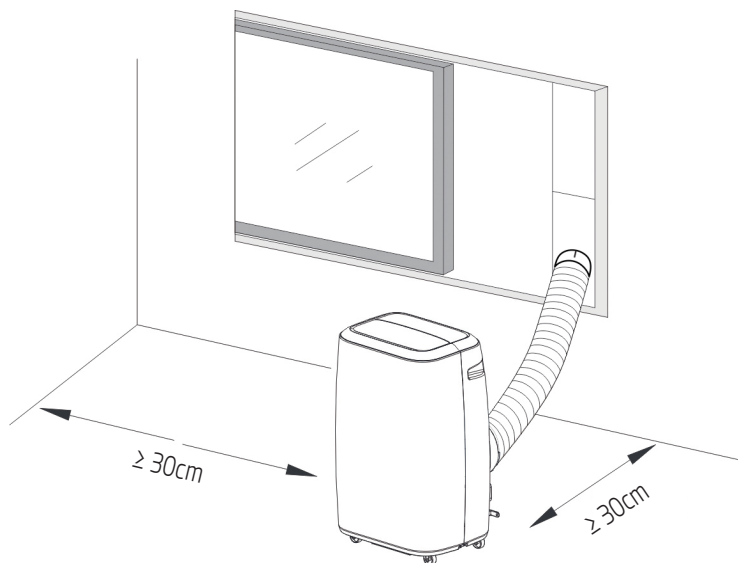

Fig. 8

7 Installation explanations

7.2 Introduction to exhaust hose installation

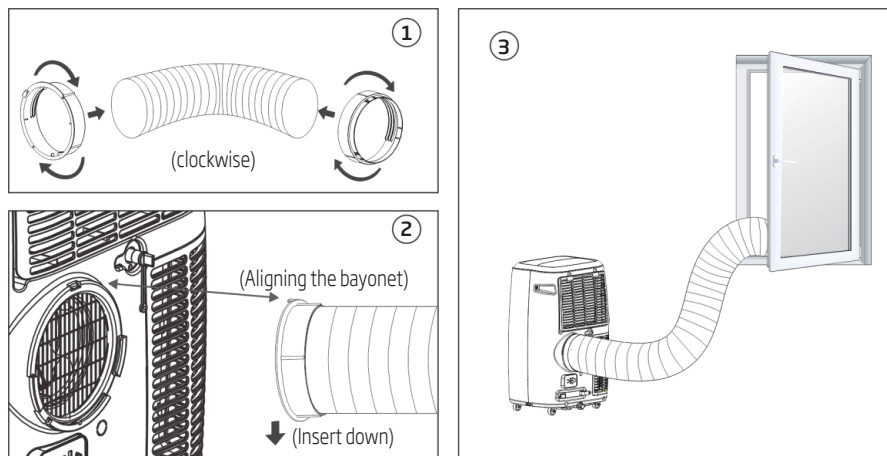

Fig. 9

Temporary installation

1. Twist both ends of the exhaust hose into the square fixing clip and the flat fixing clip.
2. Insert the square fixing clip into openings at back of the air conditioner (see Fig. 9).
3. Put the other end of the exhaust hose to the near windowsill.

Window slider kit installation

The installation manner of window slider kit is mostly in "horizontal" and "vertical". As shown Fig. 10 and Fig. 10a, check the min. and max. size of the window before the installation.

1. Install the window kit on the window (Fig. 10, Fig. 10a);
2. Adjust the length of the window slider kit according to the window width or height, and fix it with the dowel;
3. Insert the window connector hose to the hole of the window kit.

7 Installation explanations

①

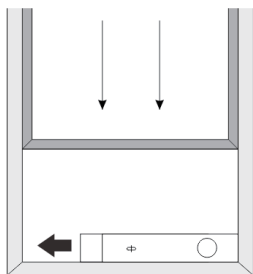

Window width
min: 67.5cm
max: 123cm

Fig. 10

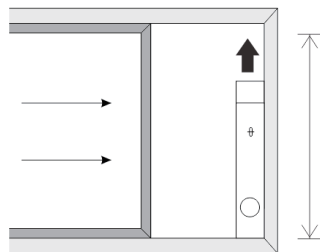

Window height
min: 67.5cm
max: 123cm

Fig. 10a

②

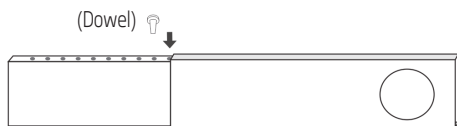

③

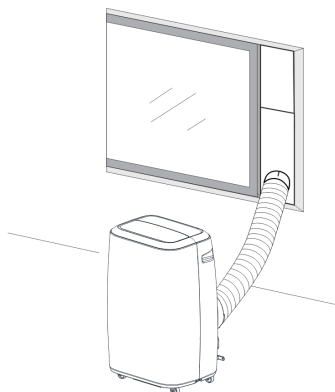
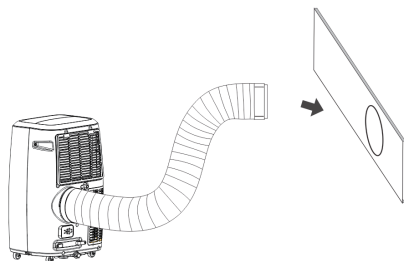

7 Installation explanations

7.3 Universal caulking kit accessory for mobile air conditioner (optional)

Suitable for windows and doors

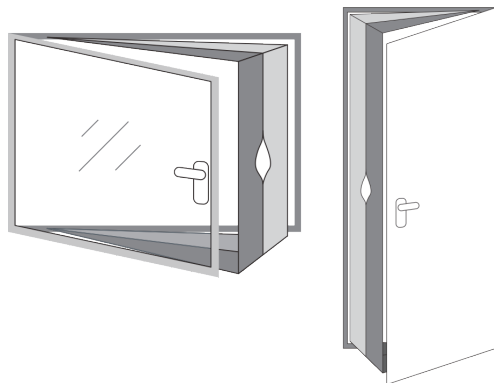

Included in this kit:

1 piece of fabric (4 m)

1 roll of tape gripping adhesive (9 m)

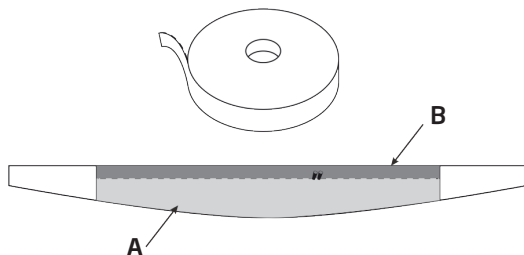

1. Open the window and clean the doors and frame before gluing the adhesive tape.

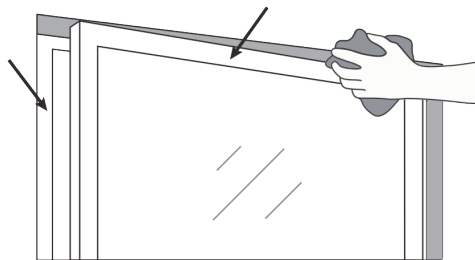

7 Installation explanations

2. Cut large strips of adhesive gripping tape to the dimensions of the window. Glue them to the frame of your window and then do the same on the inner surface of the window flap (on the side of the handle).

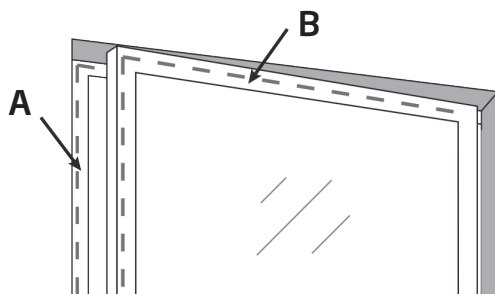

3. Glue the widest side (A) of the large white fabric piece to the window frame and then glue the narrower side (B) to the window leaf (handle side) from the center, then up and finally down.

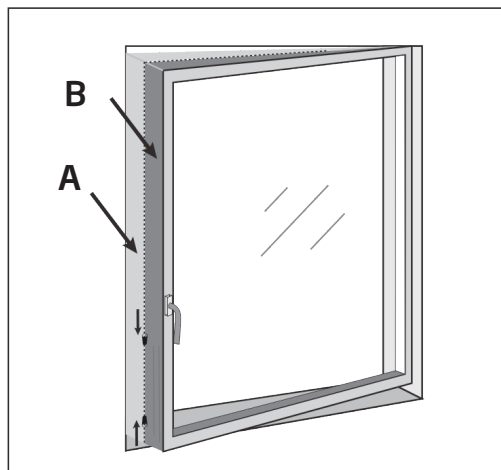

4. Close the window and make sure the large fabric piece is not stuck in the closing seams and the window closes always correctly, even with the tapes sticky adhesive tape.
5. Open the window gently and open the zipper of the fabric piece (at level of the bottom or middle of the window) then insert the exhaust duct into the opening. Readjust the zipper so that the exhaust duct is attached so that there is no air exchange between the inside and the outside.

7 Installation explanations

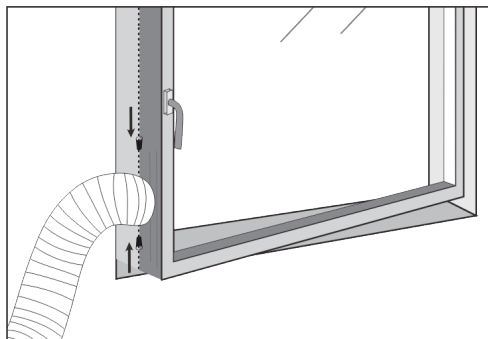

6. Your caulk kit is now installed, you can now turn on and enjoy the coolness of your mobile air conditioner!

If you no longer want to use your mobile air conditioner and close your window, you can simply remove the sheath from the zipper and close your window, in verifying that the fabric piece is not stuck in the closing seals.

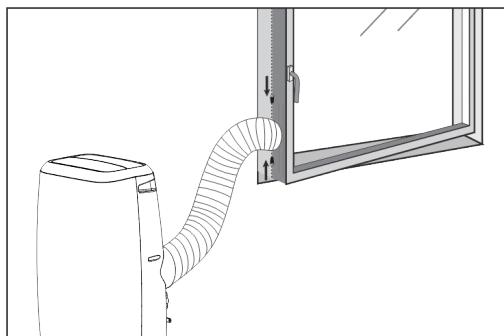

Note:



If you have a window with French opening with two leaves: Block the first leaf with the handle and make the installation of the caulk kit on the second leaf (without the handle).
Before installation, check that the adhesive gripping tape do not damage your window.

7 Installation explanations

7.4 Use the Hepa 13 filter (only for BP113H model)

1. Putting on the Hepa 13 filter, the fresh indicator turns on.
2. In air purifier function, the cooling and dehumidifying function is invalid.
3. If you need cooling and dehumidifying function, you have to put off the Hepa 13 filter.

How to put on the Hepa 13 filter

1. Take out the unit filter.

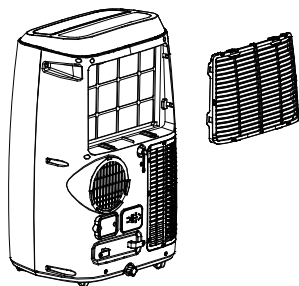

2. Put on the Hepa 13 filter.

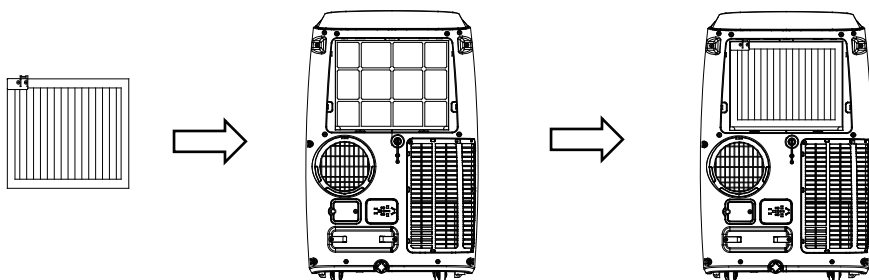

3. Put on the unit filter.

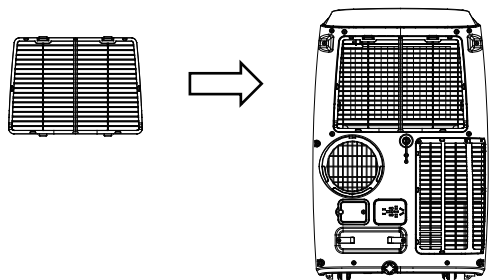

7 Installation explanations

7.5 Water full alarm

The inner water tray inside the air-conditioner has one water level safety switches, it controls water level. When water level reaches an anticipated height, the water full indicator lamp lights up. (If water pump is damaged, when the water is full, please remove the rubber blockage at the bottom of unit, and all water will be drained outside.)

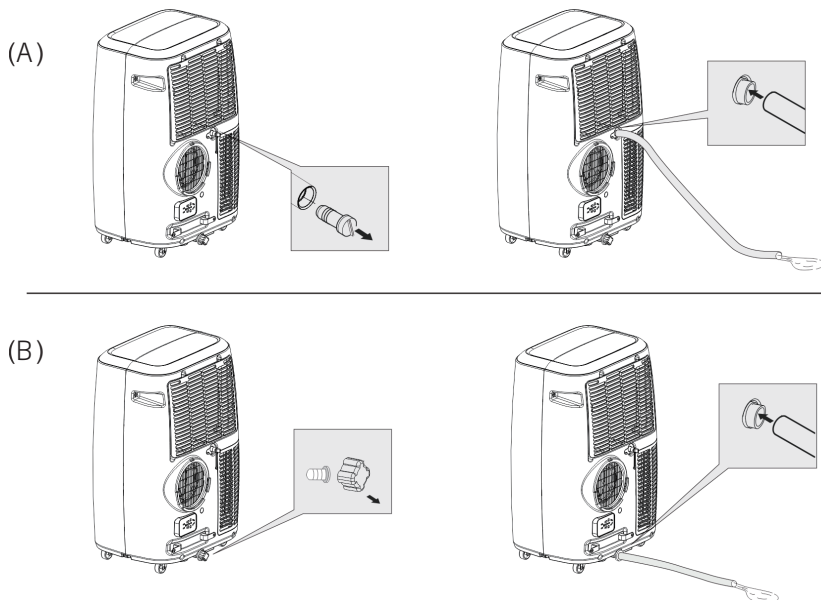

Hole (A) which is placed at the top, is to be used to extract the water from the mobile air conditioner (remove the rubber stopper and add the drain hose to the orifice) when there is a lot of humidity in the room (in continuous drainage) or when the product is operating in dehumidification or heating mode.

Hole (B) which is placed at the bottom, has a tank and is to be used when it is necessary to empty the tank (water tank alarm). Simply remove the rubber plug and add the drain hose to the hole to drain the water from the tank.

Note:



Attention depending on the filling of the water tank, there will sometimes be a lot of water to evacuate. Then the ideal would be to empty it outside or empty it over a large basin to avoid flooding your room.

8 Maintenance explanations

Warning:

- Always unplug the unit before cleaning or servicing.
- Do not use flammable liquids or chemicals to clean the unit.
- Do not wash the unit under running water. Doing so causes electrical danger.
- Do not operate the machine if the power supply was damaged during cleaning. A damaged power cord must be replaced with a new cord from the manufacturer.
- If the conditioner is damaged, please contact the dealer or repair shop.

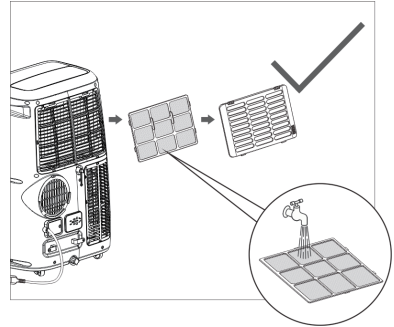
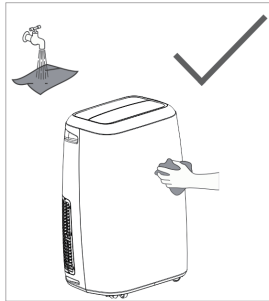
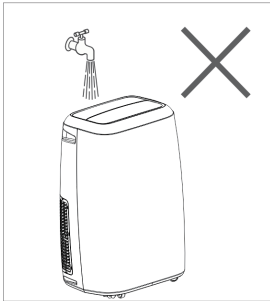

8.1 Clean the air filter

- If the air filter becomes clogged with dust/dirt, the air filter should be cleaned once every two weeks.
- Dismounting
Open the air inlet grille and take off air filter.
- Cleaning
Clean the air filter with neutral detergent in lukewarm (40°C) and dry it up in the shade.
- Mounting
Putting the air filter into the inlet grille, replace the components as they were.

8 Maintenance explanations



Warning:

Do not operate the unit without filter because dirt and lint will clog it and reduce performance.

8.2 Clean the air-conditioner surface

First clean the surface with a neutral detergent and wet cloth, and then wipe it with a dry cloth.

Maintenance tips

Be sure to clean the air filter every 2 weeks for optimal performance.

The water collection tray should be drained immediately after P1 error occurs, and before storage to prevent mold.

In households with animals, you will have to periodically wipe down the grill to prevent blocked airflow due to animal hair.

Clean the unit

Clean the unit using a damp, lint-free cloth and mild detergent. Dry the unit with a dry, lint-free cloth.

Store the unit when not in use

Drain the unit's water collection tray according to the instructions in the following section.

Run the appliance on Fan mode for 12 hours in a warm room to dry it and prevent mold.

Turn off the appliance and unplug it.

Clean the air filter according to the instructions in the previous section. Reinstall the clean, dry filter before storing.

Remove the batteries from the remote control.

Be sure to store the unit in a cool, dark place. Exposure to direct sunshine or extreme heat can shorten the lifespan of the unit.



Note: The cabinet and front may be dusted with an oil-free cloth or washed with a cloth dampened in a solution of warm water and mild liquid dishwashing detergent. Rinse thoroughly and wipe dry. Never use harsh cleansers, wax or polish on the cabinet front. Be sure to wring excess water from the cloth before wiping around the controls. Excess water in or around the controls may cause damage to the unit.

10 Troubleshooting

Troubles	Possible causes	Suggested remedies
1. Unit does not start when pressing on/off button	- Water full indicator lamp blinks, and water tank is full.	Dump the water out of the water tank.
	- Room temperature is higher than the setting temperature. (Heating mode)	Reset the temperature
	- Room temperature is lower than the setting temperature. (Cooling mode)	Reset the temperature
2. Not cool enough	- The doors or windows are not closed.	Make sure all the windows and doors are closed.
	- There are heat sources inside the room.	Remove the heat sources if possible
	- Exhaust air hose is not connected or blocked.	Connect or clean the exhaust air hose.
	- Temperature setting is too high.	Reset the temperature
	- Air inlet is blocked.	Clean the air inlet.
3. Noisy	- The ground is not level or not flat enough	Place the unit on a flat, level ground if possible
	- The sound comes from the flowing of the refrigerant inside the air conditioner	It is normal.
4. E0 Code	Room temperature sensor failed	Replace room temperature sensor (the unit can also work without replacement.)
5. E1 Code	Condenser temperature sensor failed	Replace condenser temperature sensor
6. E2 Code	Water tank full when cooling	Take off rubber stopper and empty the water.
7. E3 Code	Evaporator temperature sensor failed	Replace evaporator temperature sensor
8. E4 Code	Water tank full when heating	Please empty the water tank.



Note: The real products may look different.

11 European disposal guideline

When using this unit in the European countries, the following information must be followed:

Disposal: Do not dispose this product as unsorted municipal waste. Collection of such waste separately for special treatment is necessary.

It is prohibited to dispose of this appliance in domestic household waste.

For disposal, there are several possibilities:

- The municipality has established collection systems, where electronic waste can be disposed of at least free of charge to the user.
- When buying a new product, the retailer will take back the old product at least free of charge.
- The manufacture will take back the old appliance for disposal at least free of charge to the user.
- As old products contain valuable resources, they can be sold to scrap metal dealers.

Wild disposal of waste in forests and landscapes endangers your health when hazardous substances leak into the ground-water and find their way into the food chain.



This symbol indicates that this product shall not be disposed with other household wastes at the end of its service life. Used device must be returned to official collection point for recycling of electrical and electronic devices. To find these collection systems please contact to your local authorities or retailer where the product was purchased. Each household performs important role in recovering and recycling of old appliance. Appropriate disposal of used appliance helps prevent potential negative consequences for the environment and human health.

12 Installation instructions

12.1 F-Gas instruction

This product contains fluorinated greenhouse gases.

The fluorinated greenhouse gases are contained in hermetically sealed equipment.

Installs, services, maintains, repairs, checks for leaks or decommissions equipment and product recycling should be carried out by natural persons that hold relevant certificates.

If the system has a leakage detection system installed, leakage checks should be performed at least every 12 months, make sure system operate properly.

If product must be performed leakage checks, it should specify Inspection cycle, establish and save records of leakage checks.



Note: For hermetically sealed equipment, Local air conditioner, window air conditioner and dehumidifier, if CO₂ equivalent of fluorinated greenhouse gases is less than 10 tonnes, it should not perform leakage check.

13 Specifications

Beko Model Name	BP109C	BP112C	BP112H	BP113H	BP109AC	BP109AH
Refrigerant	R290	R290	R290	R290	R290	R290
Total refrigerant amount (g)	212	226	226	225	230	230
Climate class	T1	T1	T1	T1	T1	T1
Cooling capacity (Btu/h)	8871	11942	11942	12966	8530	8530
Cooling capacity (W)	2600	3500	3500	3800	2500	2500
Heating capacity (Btu/h)	-	-	8871	10577	-	7165
Heating capacity (W)	-	-	2600	3100	-	2100
Energy efficiency cooling (W/W) -EER	2.60	2.60	2.60	2.60	3.10	3.10
Energy efficiency heating (W/W) -COP	-	-	2.30	2.30	-	2.60
Energy level-cooling	A (EU 626/2011)	A (EU 626/2011)	A (EU 626/2011)	A (EU 626/2011)	A+ (EU 626/2011)	A+ (EU 626/2011)
Energy level-heating	-	-	A (EU 626/2011)	A (EU 626/2011)	-	A+ (EU 626/2011)
Cooling power input (W)	1000	1346	1346	1462	806	806
Heating power input (W)	-	-	1130	1348	-	807
Voltage/Frequency (V/Hz)	220-240V~/50Hz	220-240V~/50Hz	220-240V~/50Hz	220-240V~/50Hz	220-240V~/50Hz	220-240V~/50Hz
Noise power level (dBA) - (sound power)	65/63/61	65/63/61	65/63/61	65/63/61	65/63/61	65/63/61
Noise pressure level (dBA) - (sound pressure)	52/50/48	52/50/48	52/50/48	52/50/48	52/50/48	52/50/48
Air flow volume (m ³ /h)	380	380	380	440	380	380
Moisture removal (L/h)	1.0	1.2	1.2	1.5	1.0	1.0
Working temperature range at cooling (°C)	18°C-35°C	18°C-35°C	18°C-35°C	18°C-35°C	18°C-35°C	18°C-35°C
Working temperature Range at heating (°C)	-	-	7°C-27°C	7°C-27°C	-	7°C-27°C
Unit Net weight (KG)	28.5	30	30.5	34.5	28.5	28.5
Unit Net Dimension (mm) -(WxHxD)	440x715x335	440x715x335	440x715x335	470x764x370	440x715x335	440x715x335

13 Specifications

1. Specification are standard values calculate based on rated operation conditions. They will vary in difference work condition.
2. Our company has quick technical improvements. There will be no prior notice for any change of technical data. Please read nameplate on the air-conditioner.
3. Rated value is tested under 35/24(In.)35/24(Out).